



















EEZY S TWIST

	Preparing the Eezy S Twist	10
	Compact fold	14
	Using the harness system	16
	Using the sun canopy	20
	Adjusting the backrest	21
	Turning the seat	22

	Using the break	24
	Removing the wheels	25
	Using the rain cover	26
	Attaching the infant car seat	26
	Removing the fabric	30

	Vorbereitung des Eezy S Twist	10
	Kompakte Faltung	14
	Verwendung des Gurtsystems	16
	Verwendung des Sonnendachs	20
	Einstellen der Rückenlehne	21
	Drehen des Sitzes	22

	Benutzung der Bremse	24
	Entfernen der Räder	25
	Verwendung des Regenverdecks	26
	Anbringen der Babyschale	26
	Abnehmen der Bezüge	30



Préparation du Eezy S Twist

10



Pliage compact

14



Utilisation du harnais

16



Utilisation du canopy pare-soleil

20







Réglage du dossier

21



Rotation du siège

22

	Utilisation du frein	24
	Retrait des roues	25
	Utilisation de l'habillage pluie	26
	Installation des adaptateurs pour coque	26
	Retirer la housse du Siège Luxe	30



Preparar el Eezy S Twist

10



Pliegue compacto

14



Uso del sistema de arneses

16



Uso de la capota

20







Ajuste del respaldo

21



Rotamiento de la silla

22

	Uso del freno	24
	Extracción de las ruedas	25
	Uso de la burbuja de lluvia	26
	Colocación del adaptador del portabebés	26
	Retirar la vestidura	30

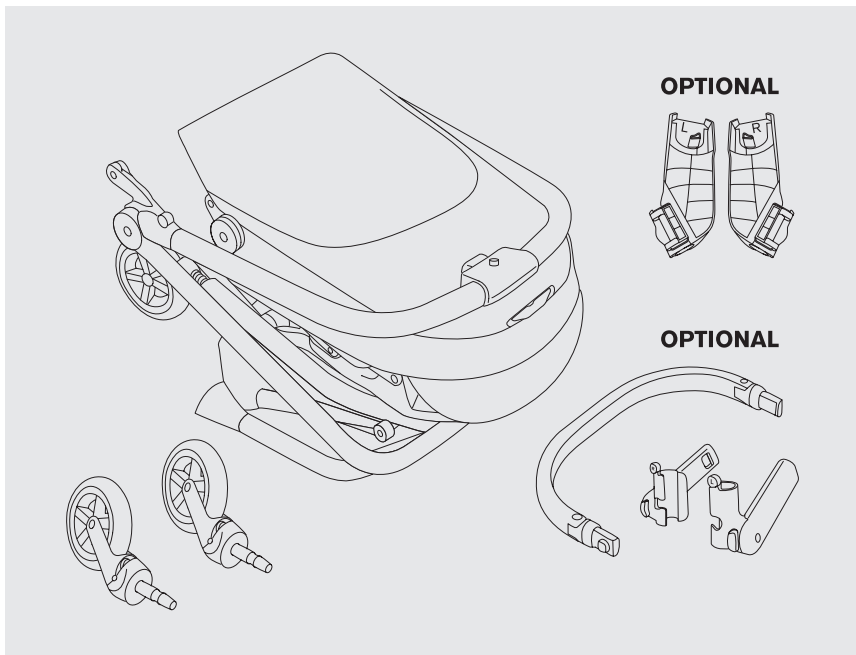

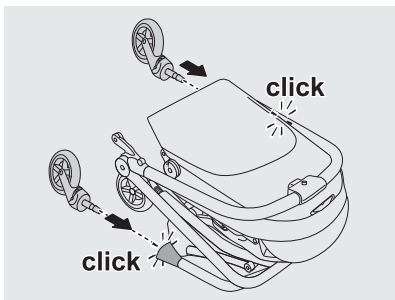

2

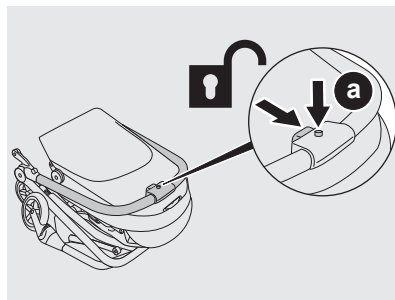

3

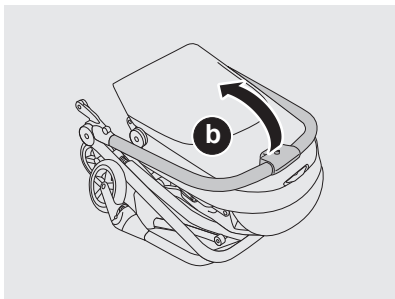

4



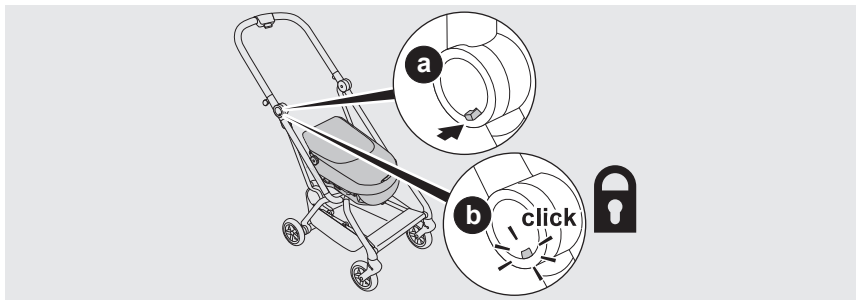

5

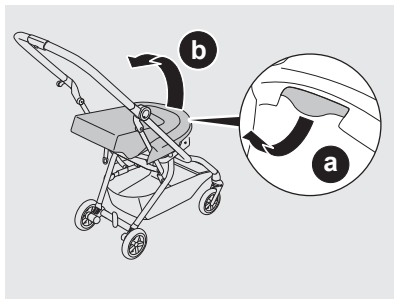

6



7



8



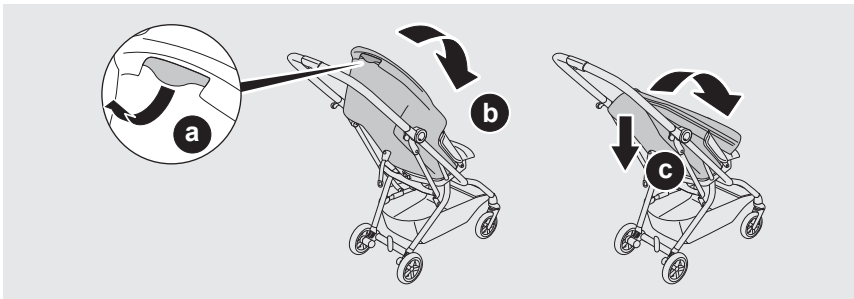

1

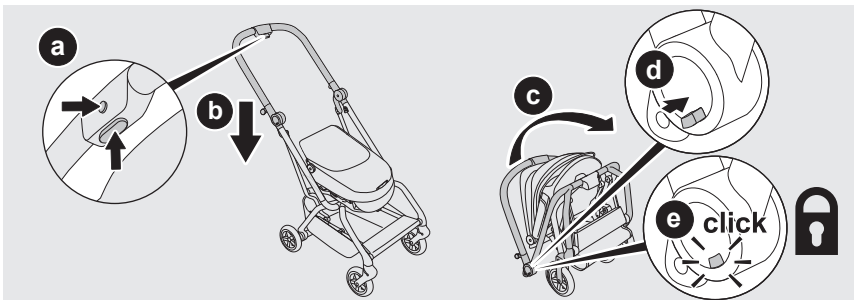

2

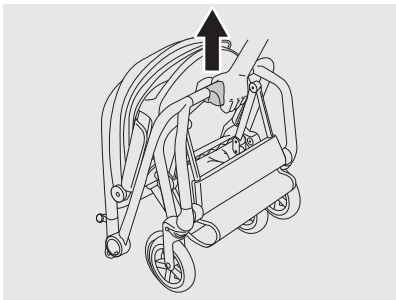

3



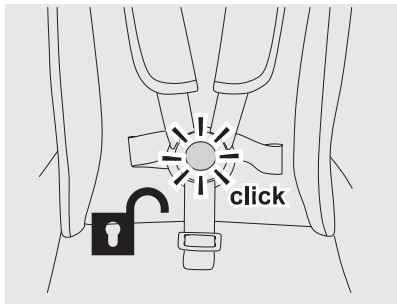

1

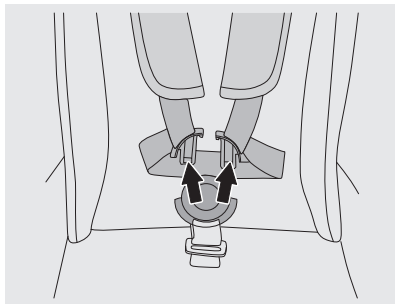

2

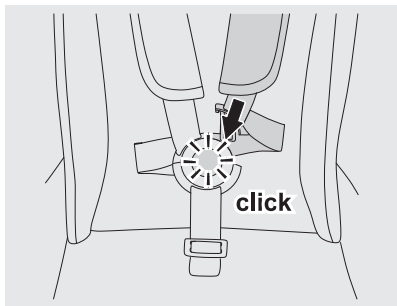

3

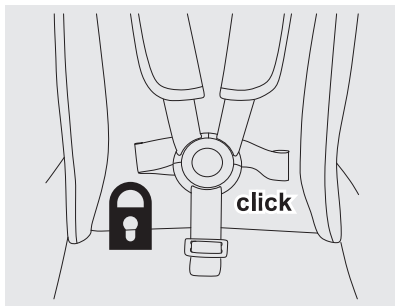

4

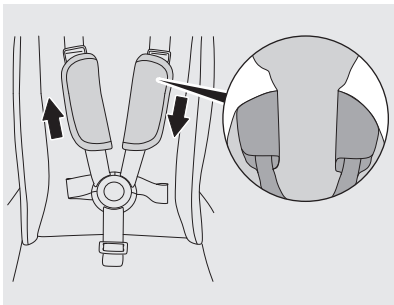

5

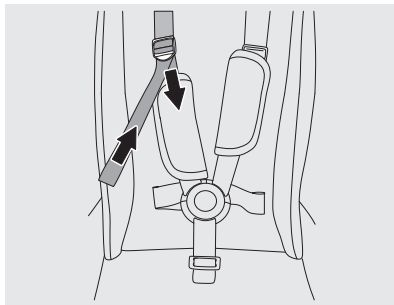

6

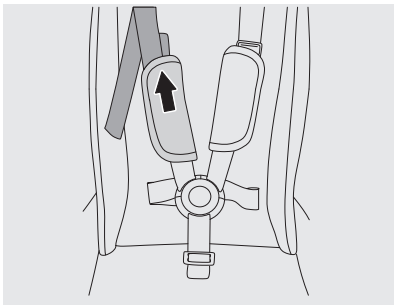

7

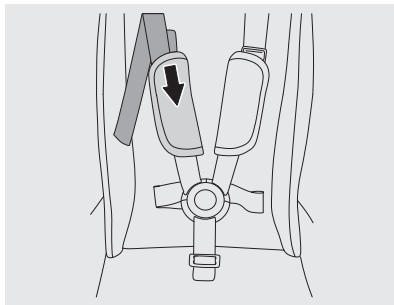

8



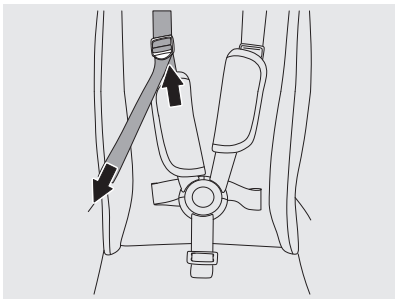

9

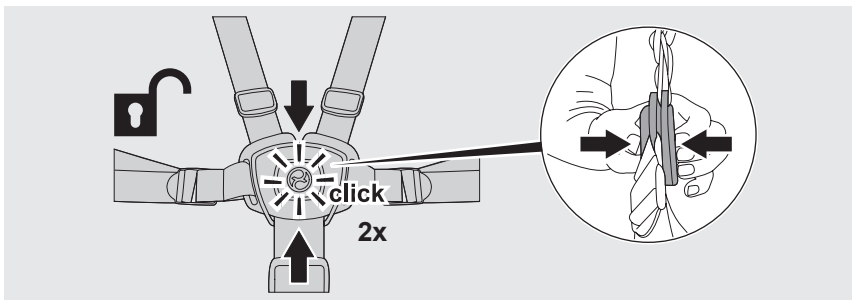

1

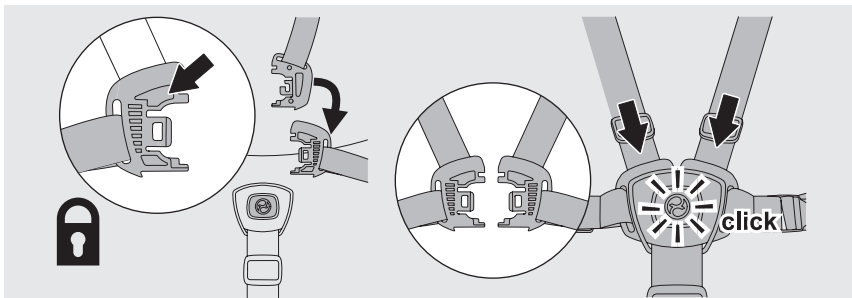

2



1



2



3

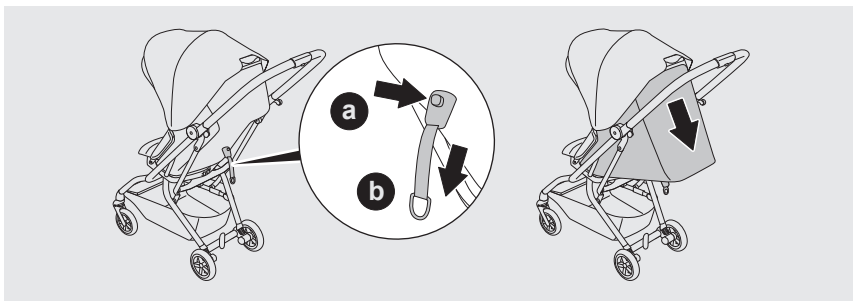

1

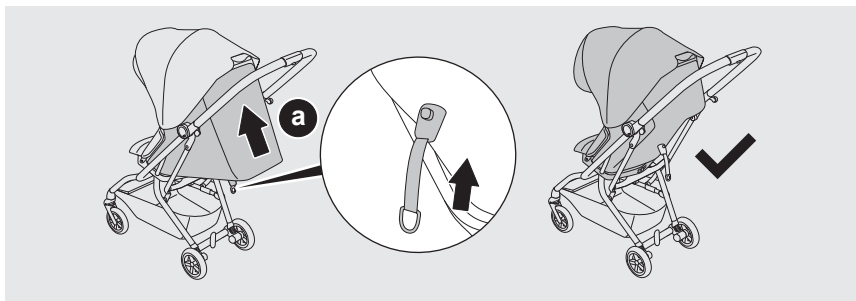

1

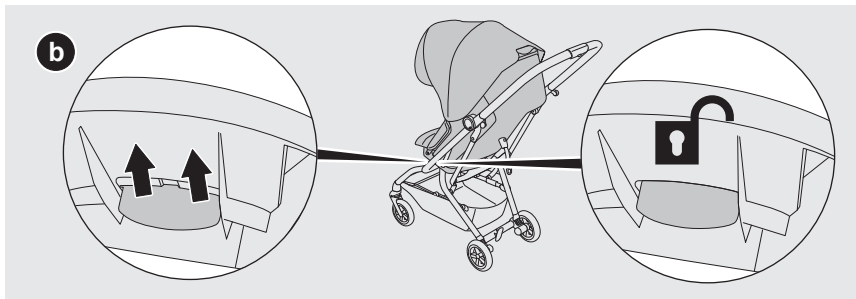

2

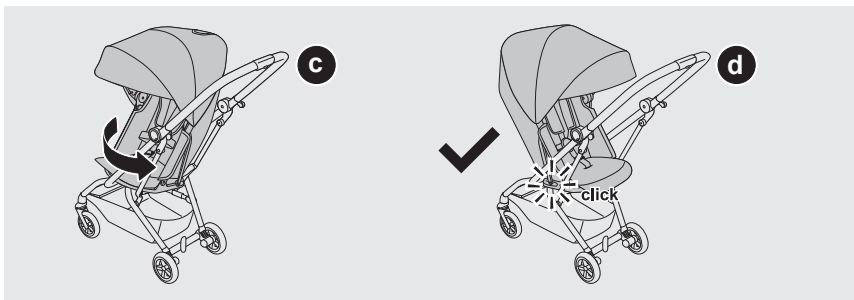

3

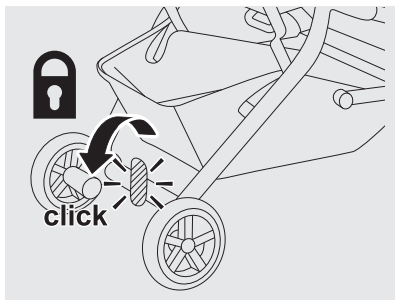

1

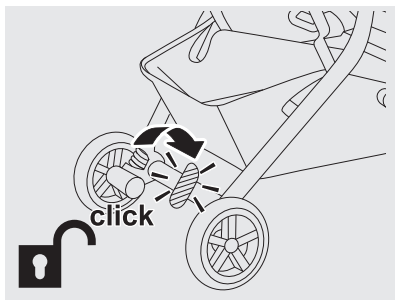

2

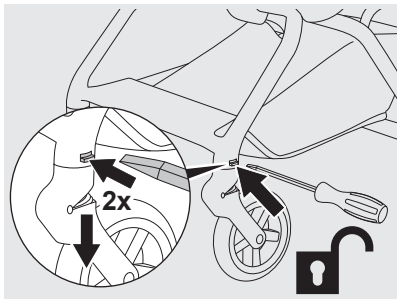

1

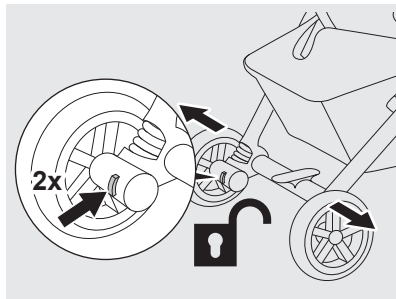

2





1

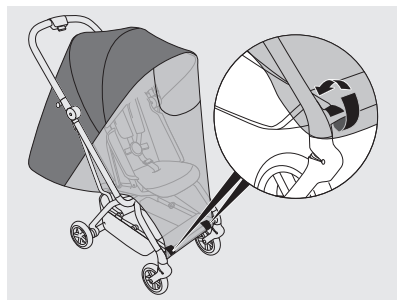

2

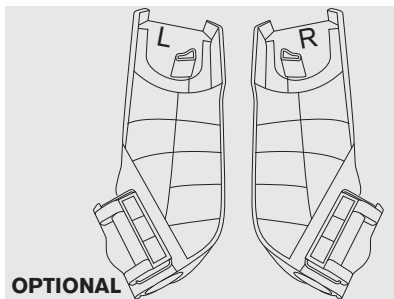

1

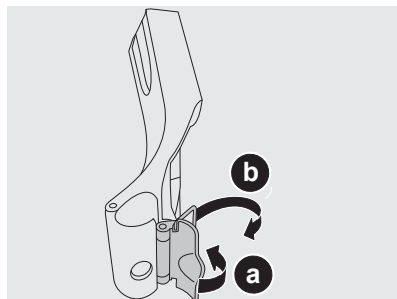

2

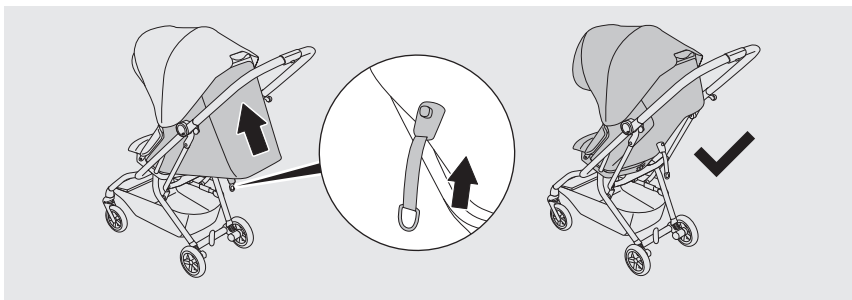

3

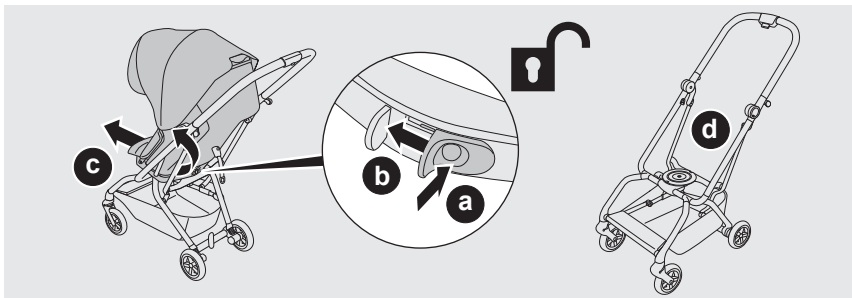

4

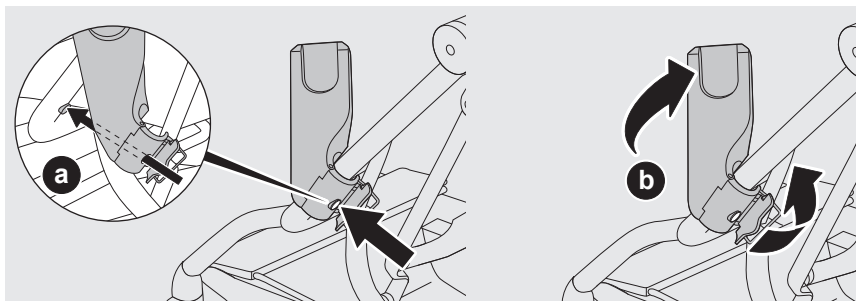

5

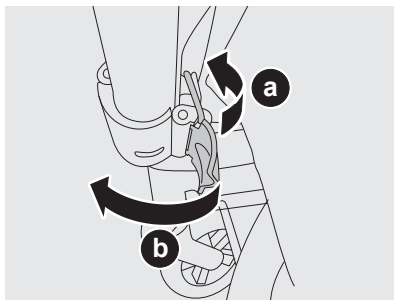

6



7



8

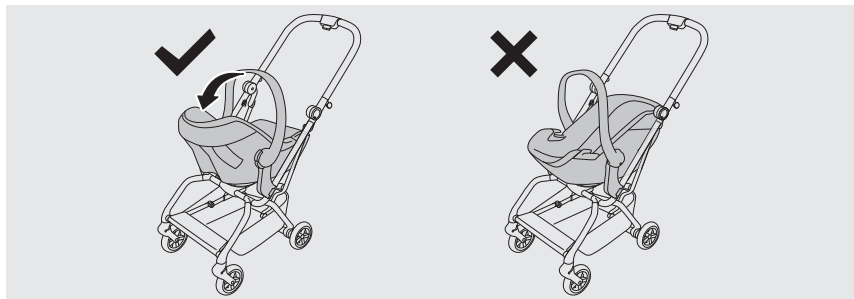

9

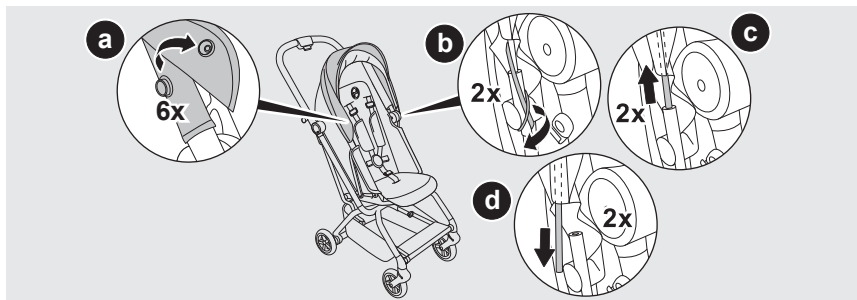

1

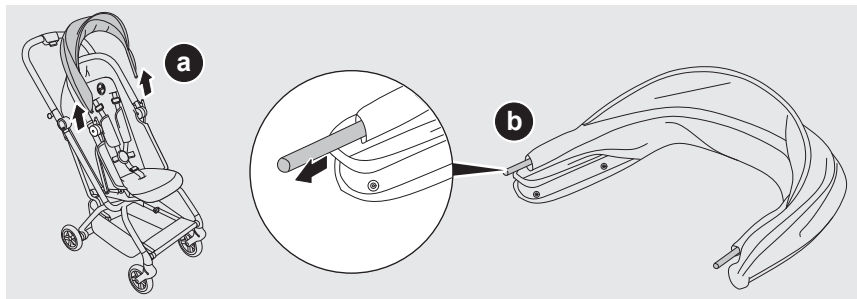

2

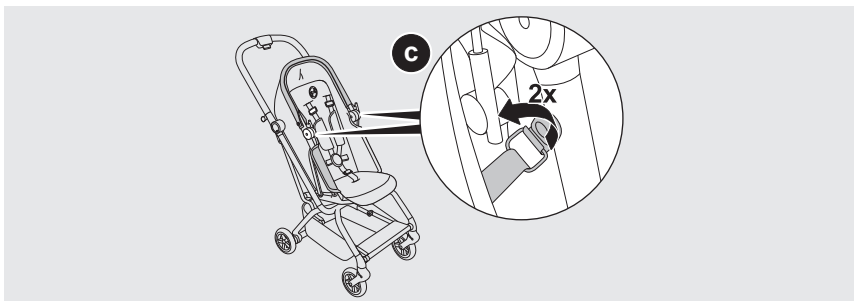

3

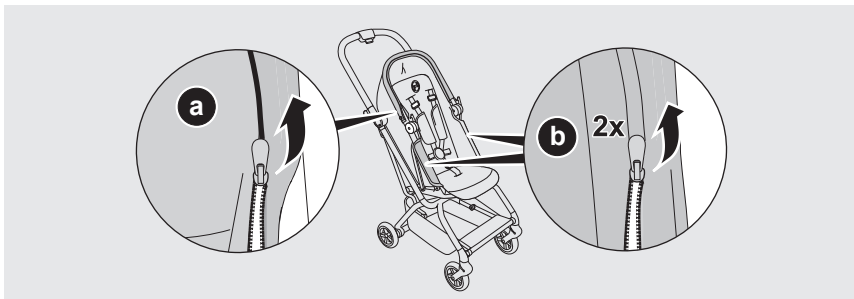

4



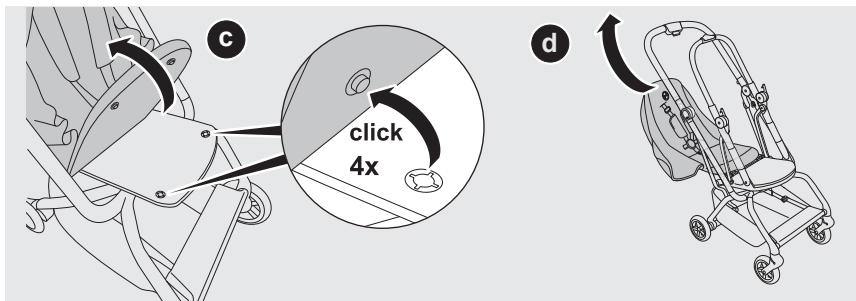

5

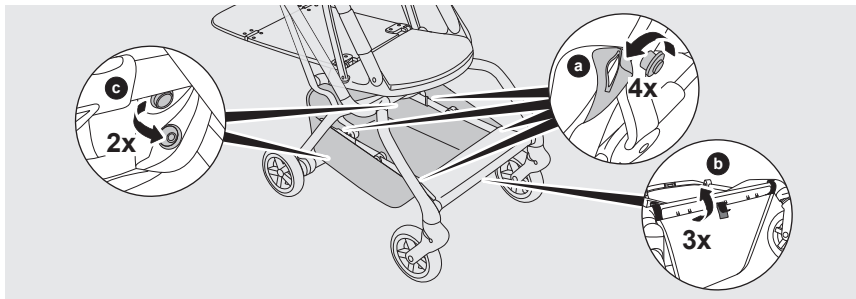

6

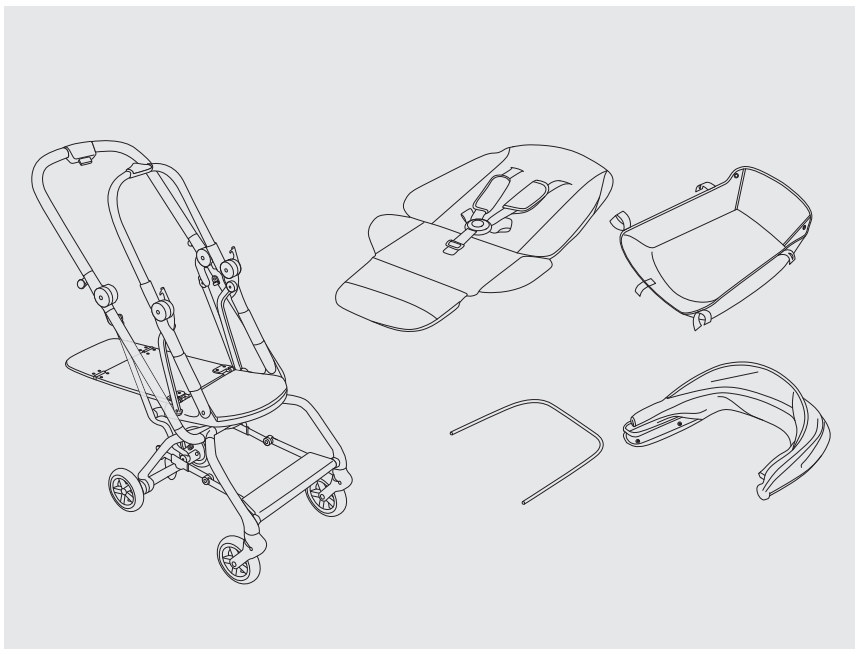

CONTACT

EUROPE AND ASIA

CYBEX GmbH
Riedingerstr. 18
95448 Bayreuth
Germany
+49 (0) 921-78 511 - 0
info@cybex-online.com

AUSTRALIA

CNP Brands
20 Calarco Drive, VIC, 3030
Australia
Customer Service 1300 667 137
info@cnpbrands.com.au

AMERICAS

Columbus Trading-Partners USA Inc.
1801 Commerce Dr.
Piqua, OH 45356
USA
Customer Service 1-844-543-2020
support.us@columbustp.com

NEW ZEALAND

Wainhouse Distribution,
2-6 Argyle St, Morningside,
PO Box 41-014, St Lukes, Auckland,
New Zealand
Customer Service: 0800 567 5000
helpline@wainhousedist.co.nz



www.cybex-online.com