

 **cybex**
GOLD

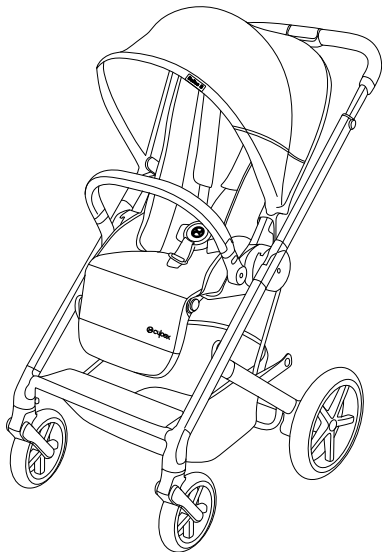

BALIOS S



Preparing the Balios S

10



Using the XXL sun canopy

14



Using the bumper bar

15



Using the brake

16



Adjusting the handle bar

16



Adjusting the seat position

17











Adjusting the leg rest









18



Using the harness system

18

	Compact fold	22
	Free-standing position	24
	Using the swivel locks	24
	Removing the wheels	25
	Using the raincover	26
	Attaching the infant car seat	27
	Attaching the carry cot	29
	Removing the fabric	30

	Vorbereitung des Balios S	10
	Verwendung des XXL Sonnendachs	14
	Verwendung des Schutzbügels	15
	Benutzung der Bremse	16
	Einstellen des Schiebegriffs	16
	Einstellen der Rückenlehne	17
	Einstellen der Beinauflage	18
	Verwendung des Gurtsystems	18

	Kompakte Position	22
	Selbststehende Position	24
	Feststellen der Vorderräder	24
	Entfernen der Räder	25
	Verwendung des Regenverdecks	26
	Anbringen der Babyschale	27
	Anbringen des Kinderwagenaufsatzes	29
	Abnehmen der Bezüge	30



Подготовка Valios S

10



Использование солнцезащитного козырька XXL

14



Использование бампера

15



Тормоз

16



Регулировка ручки

16



Регулировка сиденья

17











Регулировка подножки

18



Использование системы ремней

18

	Сложение	22
	Position debout	24
	Блокировка колес	24
	Снятие колес	25
	Использование дождевика	26
	Установка автолюльки	27
	Установка спального блока	29
	Снятие чехлов	30



Preparar el Balios S

10



Uso de la capota XXL

14



Uso de la barra apoyabrazos

15



Uso del freno

16



Ajuste del manillar

16



Ajuste del respaldo

17











Ajuste del reposapiés

18



Uso del sistema de arneses

18

	Pliegue compacto	22
	Posición de pie libre	24
	Uso del bloqueo de dirección de las ruedas delanteras	24
	Extracción de las ruedas	25
	Uso de la burbuja de lluvia	26
	Colocación del adaptador del portabebés	27
	Adaptación del capazo	29
	Retirar la vestidura del Mios	30

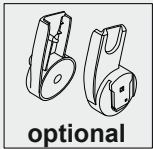
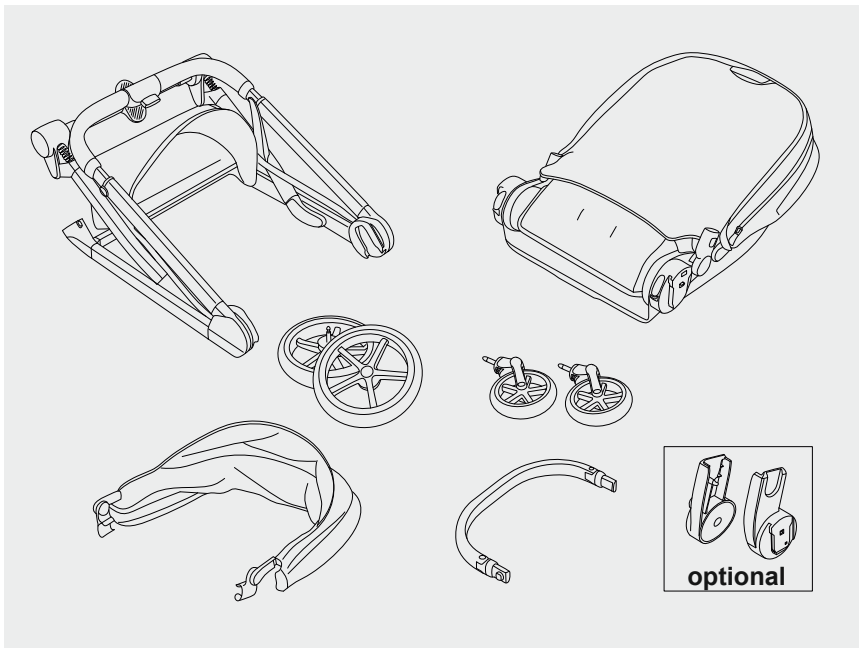

1

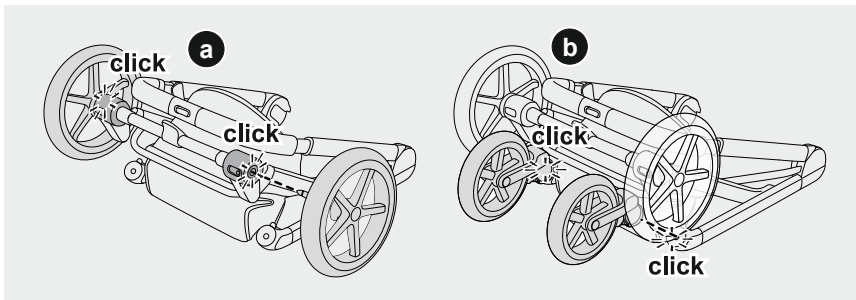

2

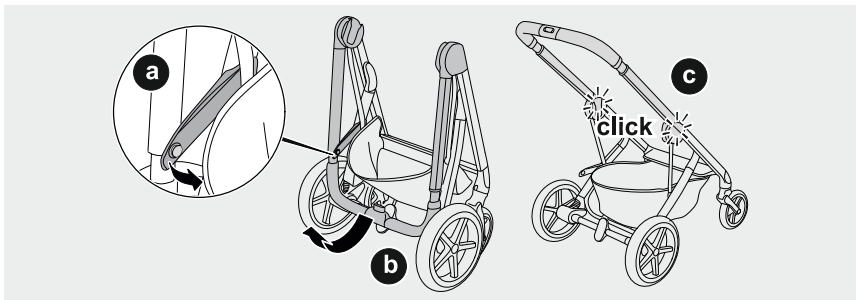

3



4



5

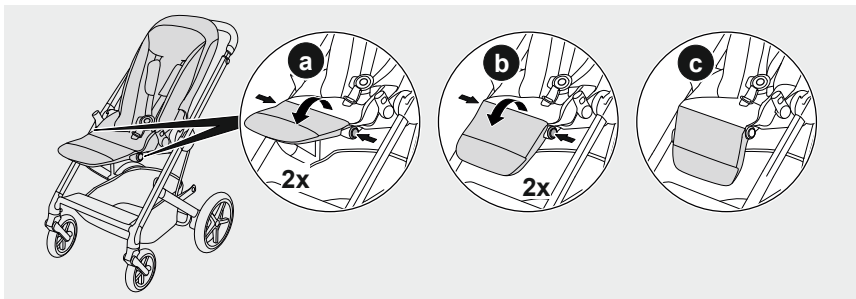

6



7

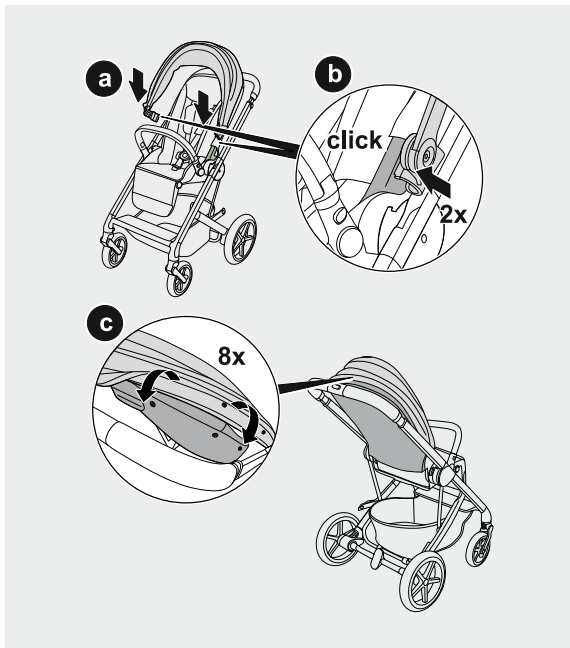

8

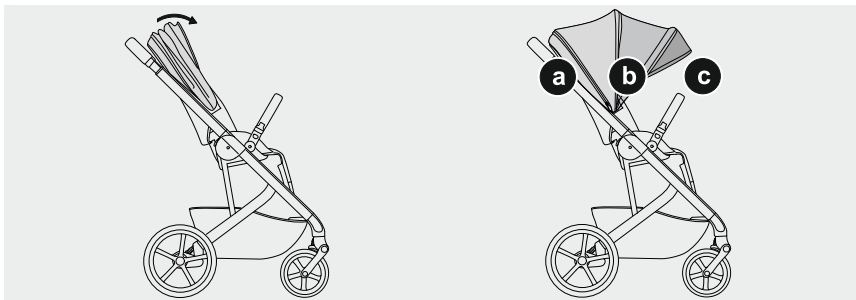

1

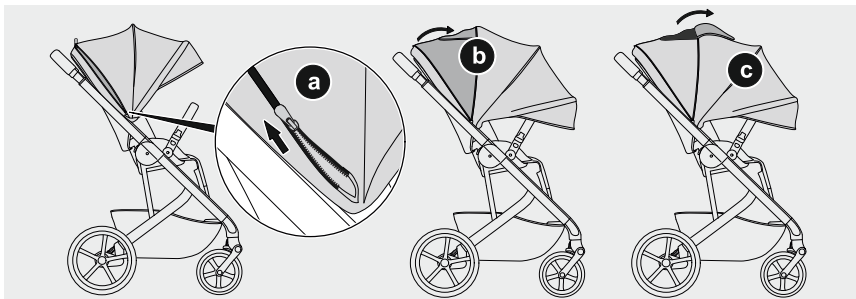

2

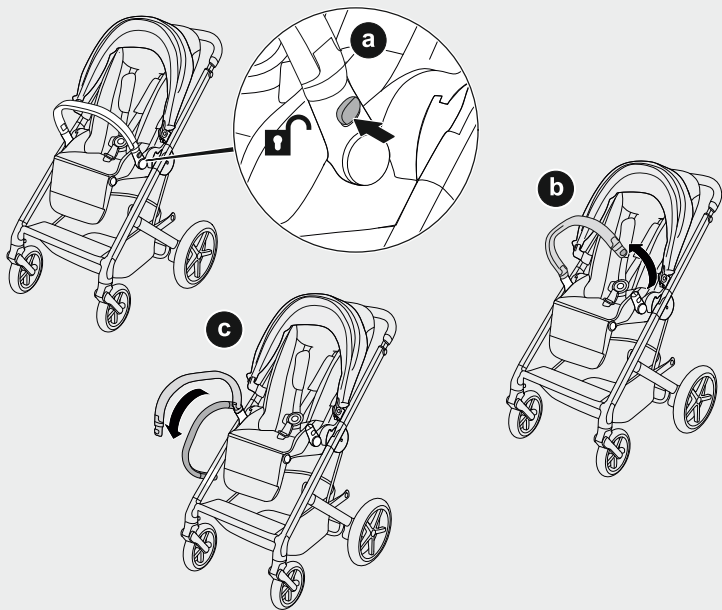

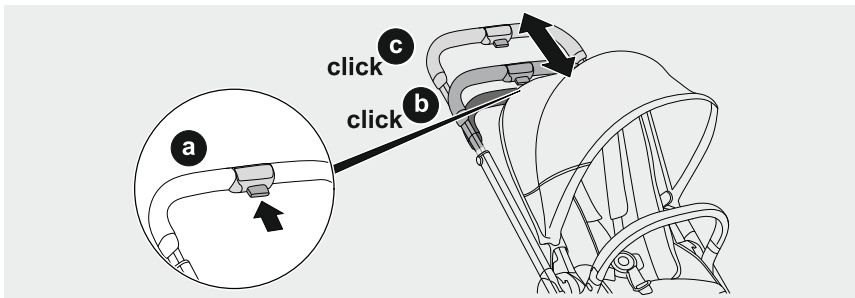
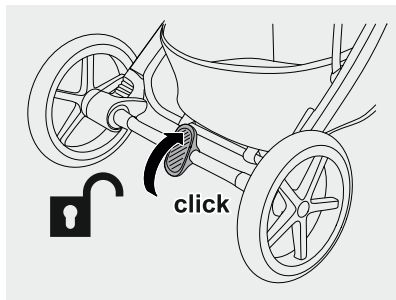
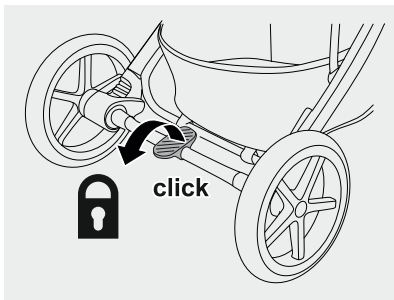

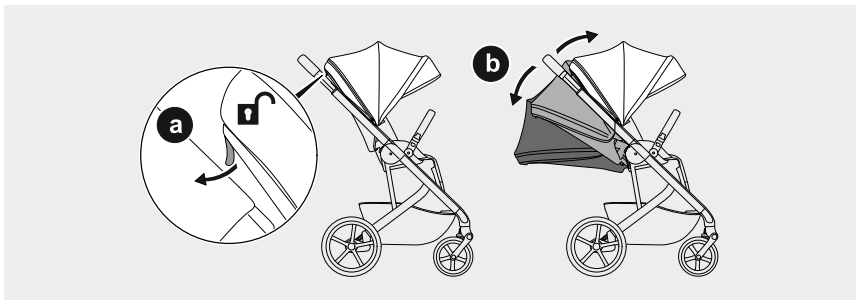

1

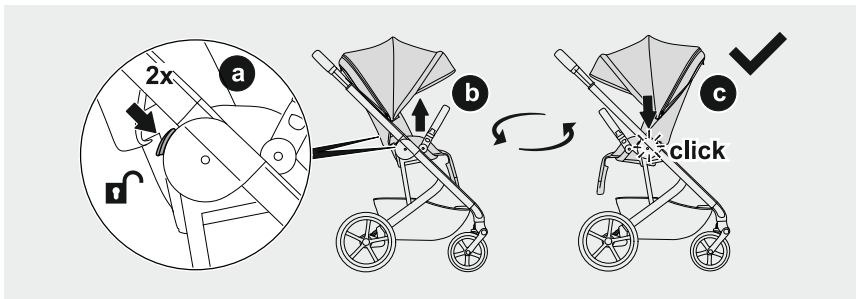

2

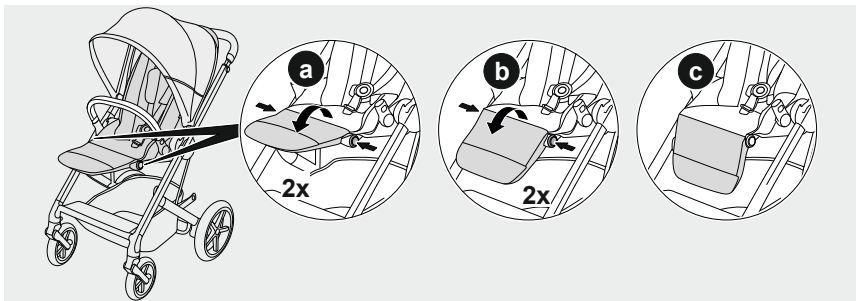

1

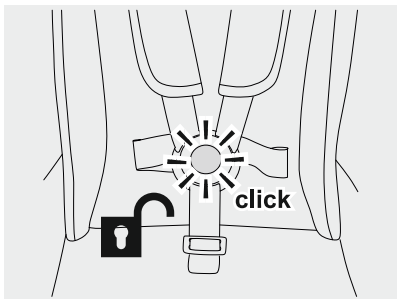

1

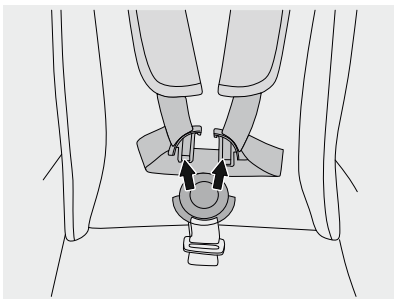

2

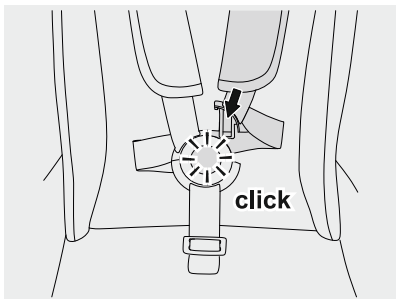

3

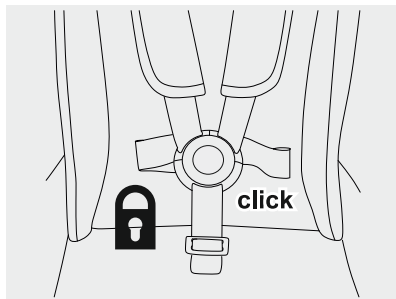

4

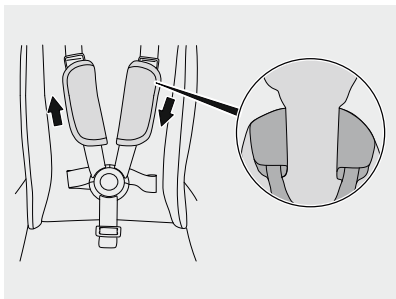

5

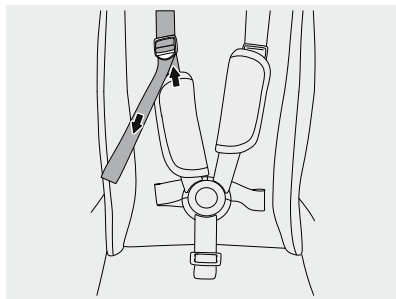

6



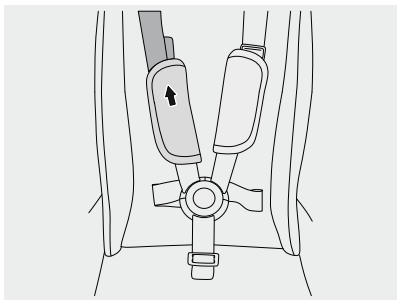

7

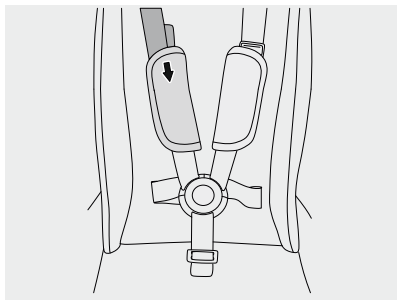

8

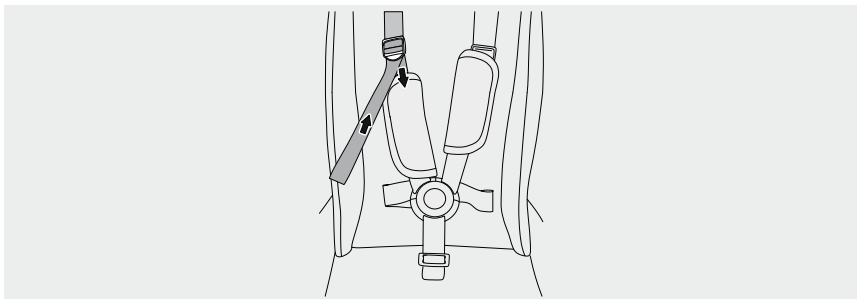

9

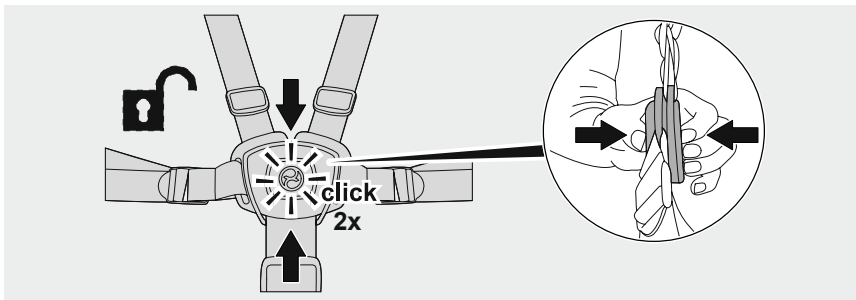

10

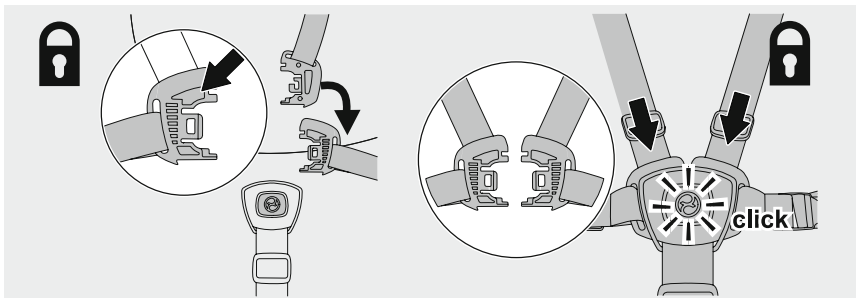

11

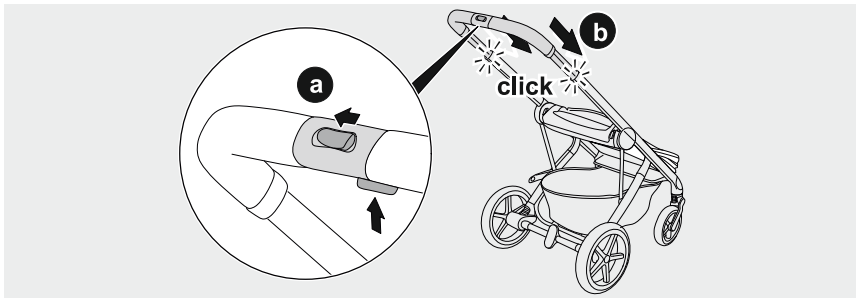
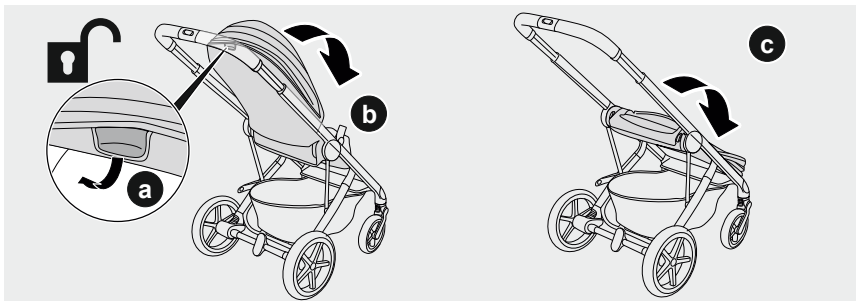

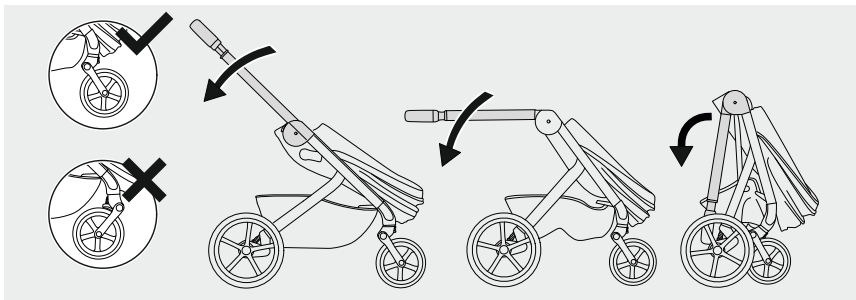

3

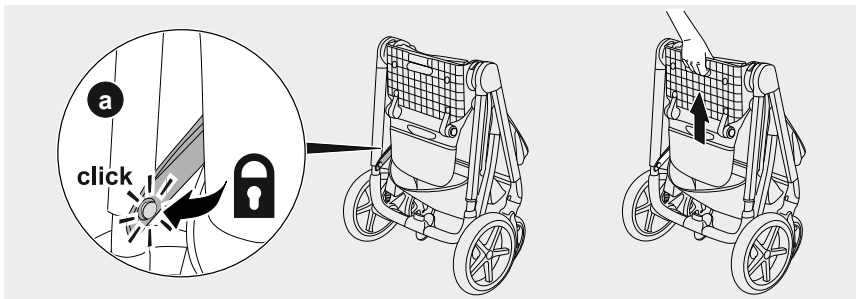

4



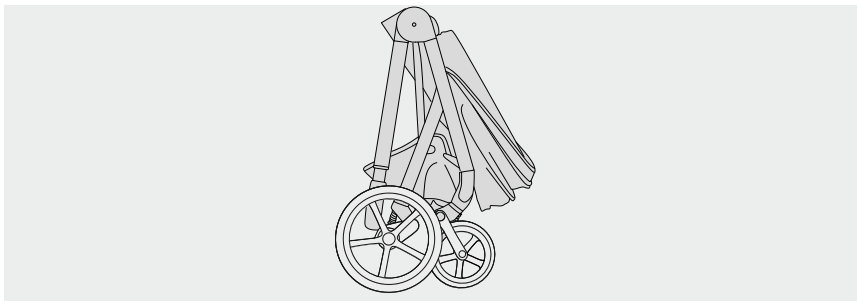

1

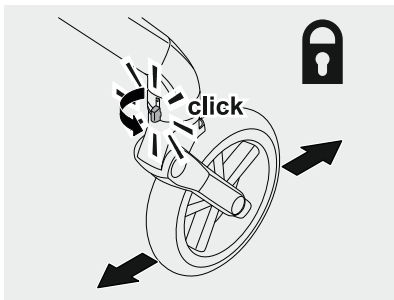

1

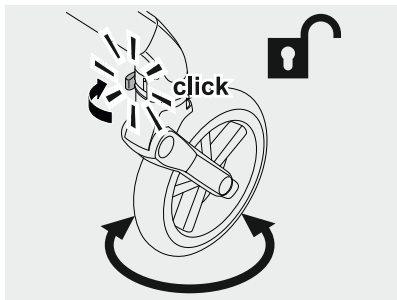

2

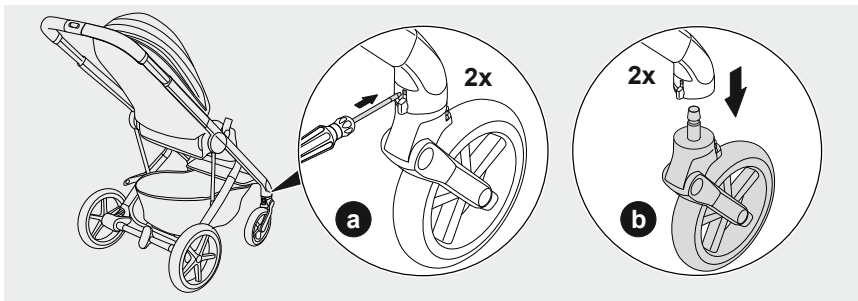

1

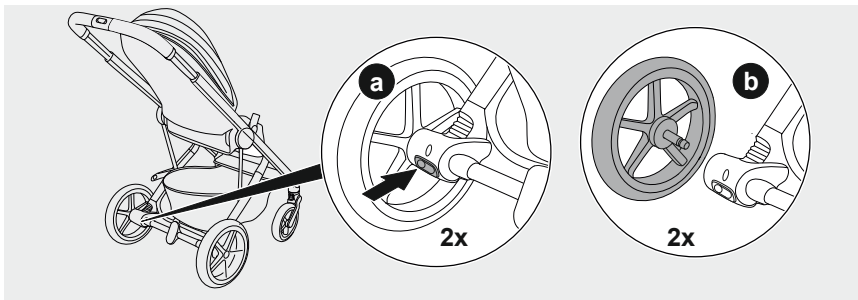

2

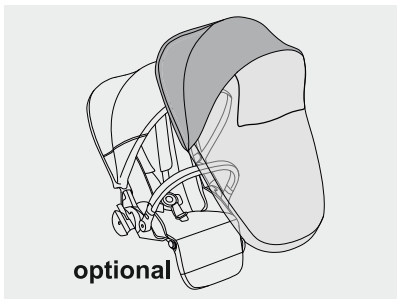

1

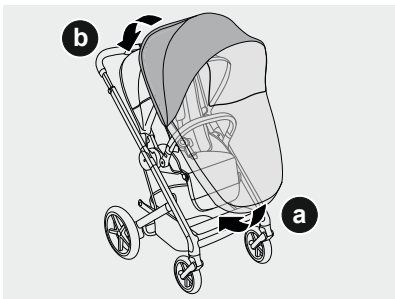

2



3

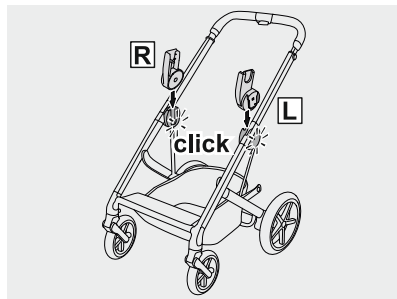
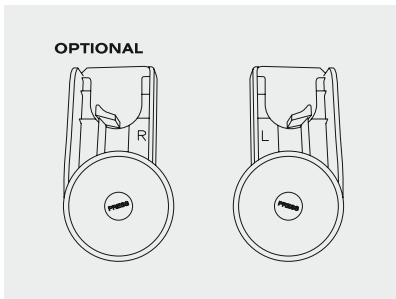

3

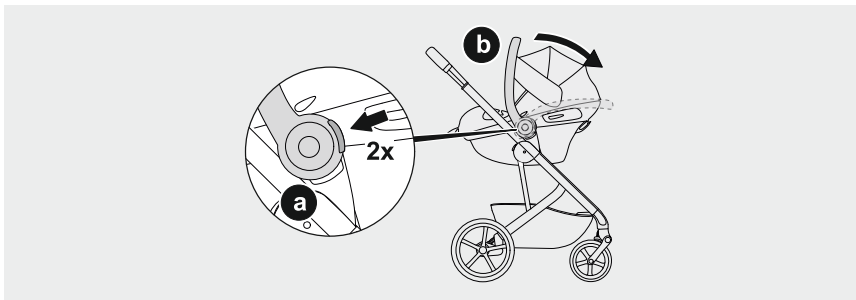

4

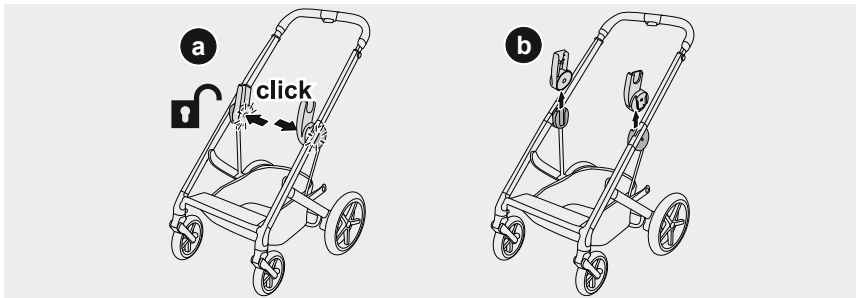

5

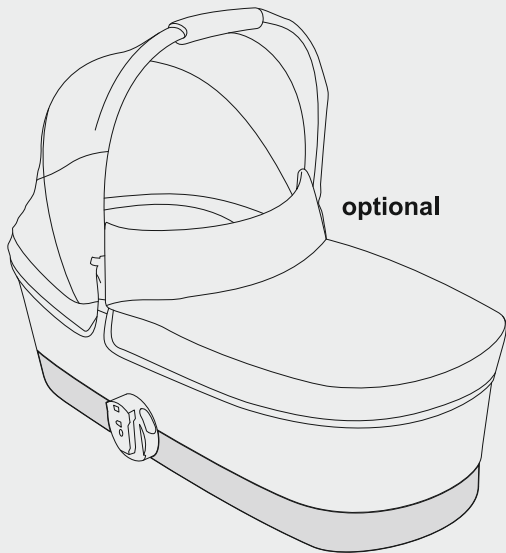



2

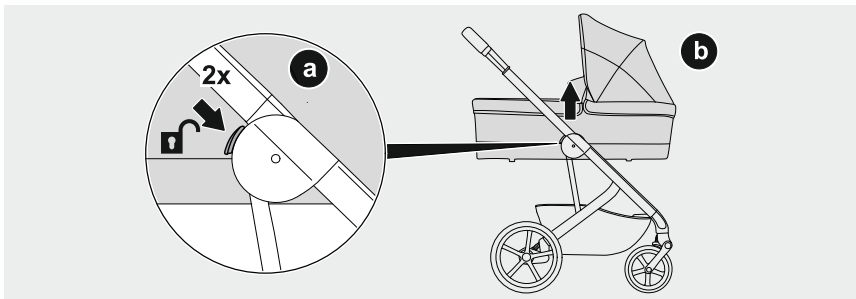

3

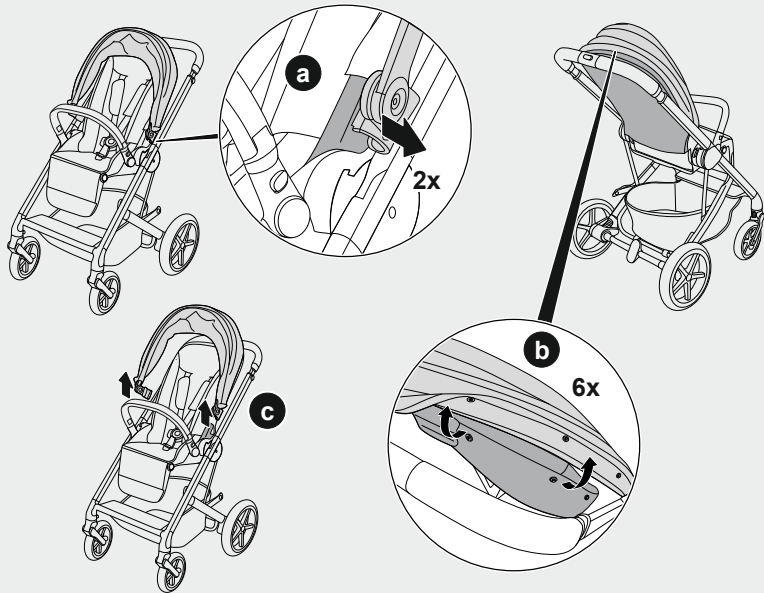

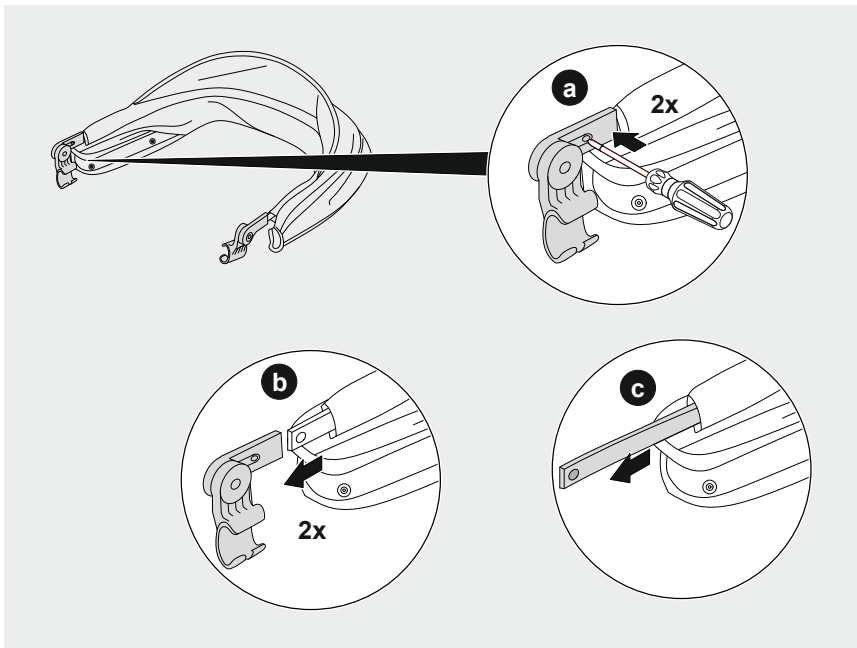

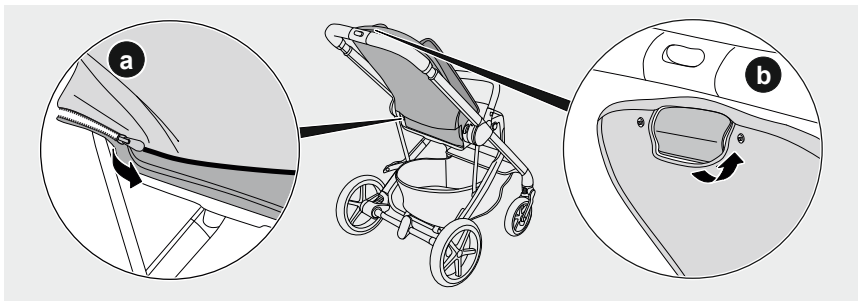

4

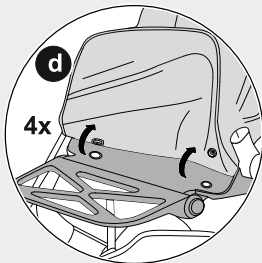
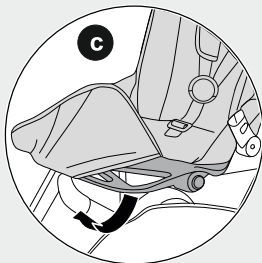
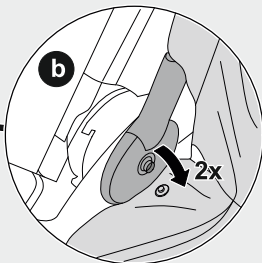

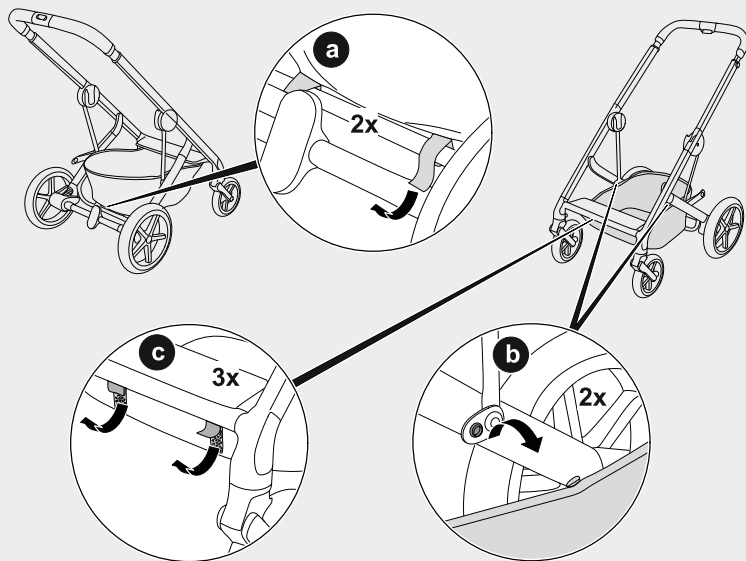

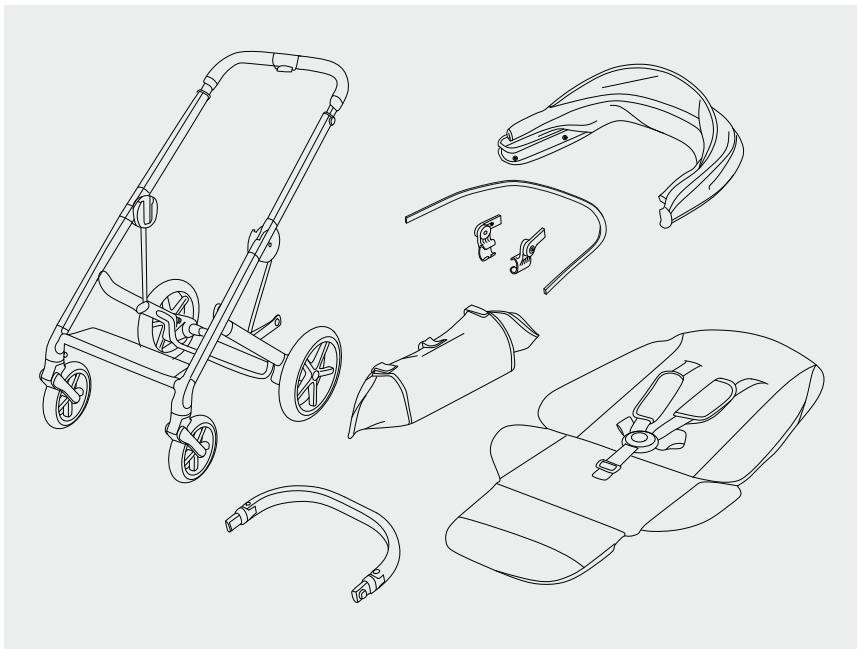

7

CONTACT

EUROPE AND ASIA

CYBEX GmbH
Riedingerstr. 18
95448 Bayreuth
Germany
+49 (0) 921-78 511 - 0
info@cybex-online.com

AMERICAS

Columbus Trading-Partners USA Inc.
560 Harrison Avenue
Suite 500
Boston, MA 02118
USA
Customer Service 1-877-242-5676
orders.us@columbustp.com

AUSTRALIA

CNP Brands
20 Calarco Drive, VIC, 3030
Australia
Customer Service 1300 667 137
info@cnpbrands.com.au

RUSSIA

Company VAK LLC
141720, Moscow Region, Paveltsevo
district, Novoe shosse 36A
+7(499) 6-700-800



www.cybex-online.com