

CONCORD **ABSORBER XT**



DEUTSCH	01
ENGLISH	21
FRANÇAIS	41
ESPAÑOL	61
ITALIANO	81
PORTUGUÊS	101
NEDERLANDS	121
NORSK	141
DANSK	161
SUOMI	181

Kindergewicht 9 kg - 18 kg
child's weight

ca. Alter 9 Monate - 4 Jahre
approx age

ECE Gruppen I
ECE group



Norm ECE R44 04
standard ECE R44 04
norme ECE R44 04
norma ECE R44 04
szabvány ECE R44 04



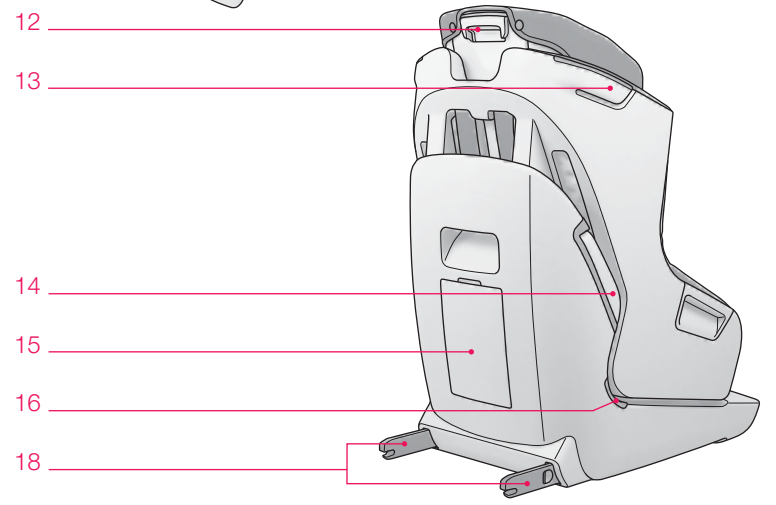
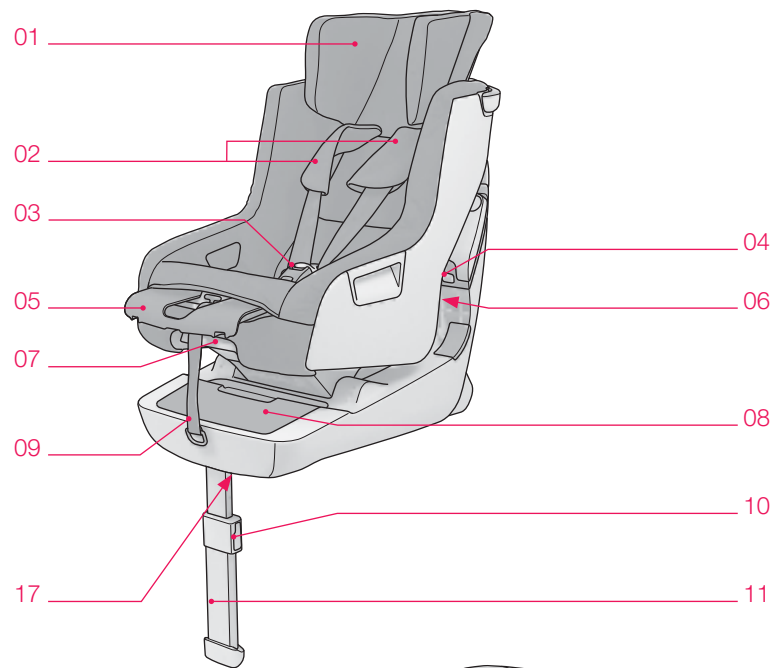

_ ENGLISH

THANK YOU	21
OVERVIEW	22
INSTRUCTIONS	24
GENERAL INFORMATION	26
USING THE CONCORD ABSORBER	26
MOUNTING THE CONCORD ABSORBER WITH THE THREE-POINT SAFETY BELT	27
REMOVING THE CONCORD ABSORBER WITH THE THREE-POINT SAFETY BELT	31
MOUNTING THE CONCORD ABSORBER WITH ISOFIX	32
REMOVING THE CONCORD ABSORBER WITH ISOFIX	34
VEHICLES SUITABLE FOR ISOFIX	35
SECURING YOUR CHILD IN THE CONCORD ABSORBER	36
USING THE TILT ADJUSTMENT	38
USING THE SUPPORT OF THE STEP-UP HELP	38
USING THE LEG SUPPORT	39
CARE TIPS	39
WARRANTY	40

_ THANK YOU

Thank you for purchasing a Concord quality product.
You will be amazed about the versatility and safety of this product.

We hope that you will enjoy using your new CONCORD ABSORBER.

_ OVERVIEW

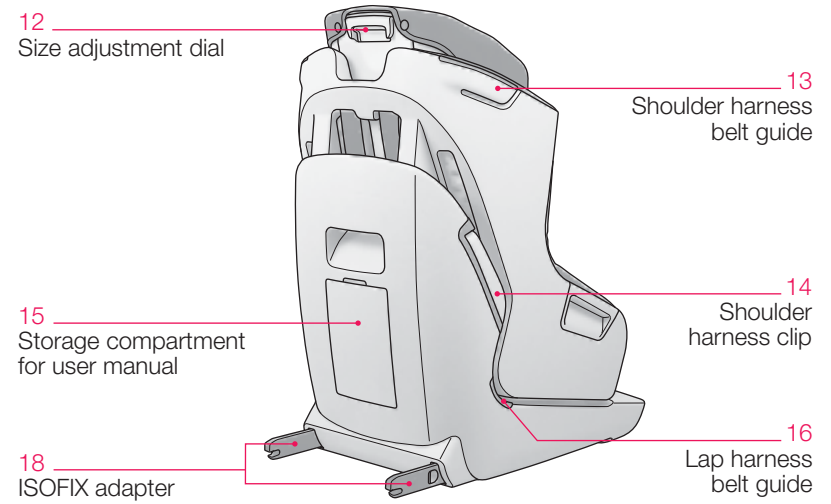
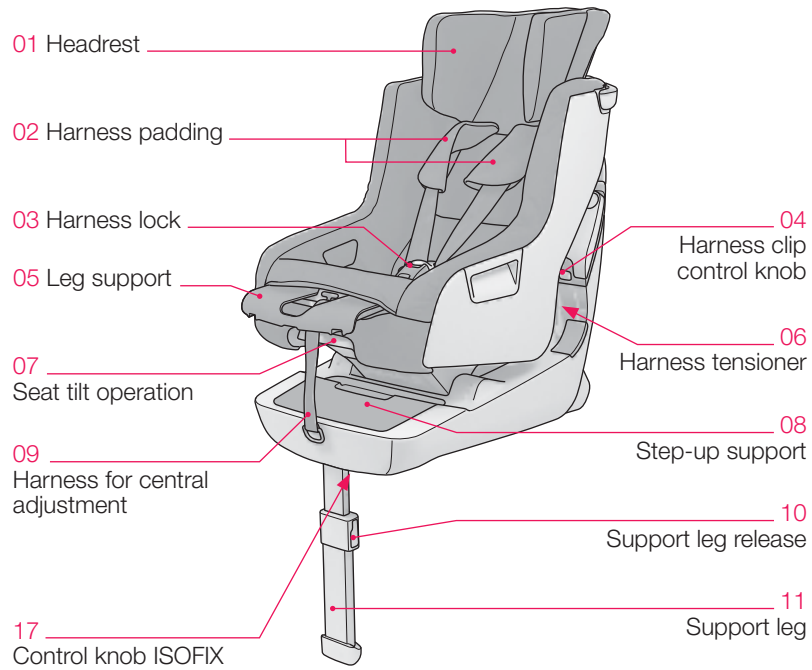

_ INSTRUCTIONS

CAUTION!

- Please read this user manual carefully before using the CONCORD ABSORBER, and make sure to store it for later reference. Non-compliance with the instructions in this manual may affect the safety of your child!
Make sure to also observe relevant instructions contained in the user manual of your vehicle before transporting children.

WARNING!

- Never leave your child unattended.
- Children often carry small objects (e.g. toys) in jacket or pants pockets, and may also wear clothes with rigid components (e.g. belt buckle). Make sure that these are not clamped between the child and the harness, as this might cause unnecessary injuries in case of an accident. The same hazards apply for adults as well!
- Naturally, kids are often lively. Make sure to explain the importance of safety when in a vehicle. Your child will then understand that the harness lock should not be opened or the harness moved, giving you more peace of mind.
- Your child's safety can only be guaranteed if the safety system is attached and used in accordance with the instruction manual.
- The system's harness straps must be worn taut and without any twists, and must be protected against any damage.
- Protect any parts of the CONCORD ABSORBER not covered with fabric against direct sunlight to prevent your child from suffering burns.
- The child restraint system must not be damaged or crushed by moving parts in the vehicle or by the vehicle doors.
- Do not attempt any modifications on the CONCORD ABSORBER, as these might infringe on your child's safety.
- After an accident, the CONCORD ABSORBER must be replaced or sent to the manufacturer for testing, along with an accident report.
- Make sure to instruct your passenger on how to remove the child from its safety seat in case of accident or danger.
- Never leave your child unsupervised in the car seat - whether harnessed or not.

- Make sure to secure any luggage and loose items in the passenger cabin to reduce the risk of injury in case of an accident.
- The manual must always be carried with the child safety seat.
- The use of any accessories or replacement parts is prohibited, and non-compliance will result in a lapse of all warranty and liability claims. Excepted are original accessories by CONCORD only.
- Suitable for vehicles with lap and diagonal seat belt, which have been approved in compliance with ECE regulation 16 or similar standard.

Due to prolonged use of the CONCORD ABSORBER, seat covers and other parts will wear depending on duration and intensity of use to varying degrees, and will have to be replaced. We can therefore not provide any blanket warranty beyond 6 months for wear parts.

Please contact your specialist shop for baby and children's products, the relevant department in department stores, your car accessory specialist shop or the catalog company, where you originally purchased the CONCORD ABSORBER for replacement parts. These will have a complete product portfolio for CONCORD child seat accessories to choose from.

The vehicle's seat belt lock must not be placed over the edge of the lap harness belt guide. If in doubt or in case of difficulties with our product, please contact CONCORD directly. The vehicle's seat belts must be placed at the positions and contact points on the safety seat as shown in the user manual. Any other seat belt placement is prohibited.

If the seat selected for mounting the child seat is equipped with an airbag, we recommend moving the seat as far back as possible. The seat's lap and diagonal seat belt must be run forward to the shoulder harness guide (13) of the child seat. Adjust the vehicle's seat position where required. For vehicles with front and lateral airbags, read the relevant instructions provided in the vehicle manual.

GENERAL INFORMATION

- This product is a ,semi universal' child restraint system. It has been approved in accordance with the ECE regulation 44, change series 04 for general use in vehicles, and will fit most but not all car seats.
- This child restraint system of ECE Group I is suitable for children between the ages of 9 months and 4 years with a body weight between 9 and 18 kg.
- Proper fit of the car seat can be assumed if the vehicle manufacturer declares the vehicle suitable for the mounting of a ,semi universal' child safety restraint for the relevant age group in his vehicle manual.
- This child safety restraint was approved in accordance with the stricter requirements of the class ,semi universal' than previous models, which do not bear this label.
- If you have any questions or doubts, please contact the manufacturer of the child safety restraint or your retailer.
- Only suitable for use in vehicles with lap and diagonal seat belt, which are approved in accordance with ECE regulation 16 or similar standard.

USING THE CONCORD ABSORBER

With the safety of your child in mind, you have decided to purchase our car seat CONCORD ABSORBER. The product is manufactured under strict quality control conditions. It will only be fully effective in terms of its safety features if used according to specifications. Please ensure strict adherence with the mounting and usage instructions.

The fabric cover is an important component and adds to the effectiveness of the seat; the seat may therefore only be used with an original CONCORD cover!

The child seat can be used on any vehicle seats that are equipped with a lap and diagonal seat belt. For reasons of results of accident statistics, however, we recommend using the seat behind the front passenger seat.

MOUNTING THE CONCORD ABSORBER WITH THE THREE-POINT SAFETY BELT

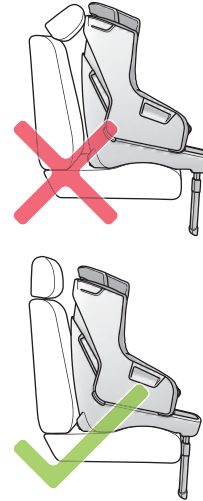

Fold the support leg (11) at the bottom of the CONCORD ABSORBER forwards until it engages.

Set down the CONCORD ABSORBER in drive direction onto the seat or the seat bench. The CONCORD ABSORBER should align with the seat and backrest with as much direct contact as possible. In vehicles with serial headrests, a readjustment of the headrest or its removal will allow for a better mounting position of the car seat.

Please remember to readjust or replace the headrest in the correct position if an adult will be sitting in that seat instead.

The car seat must be secured with the lap and diagonal seat belt, even if no child is traveling in it!

Press the size adjustment control (12) upwards and move the headrest of the CONCORD ABSORBER into its top-most position.

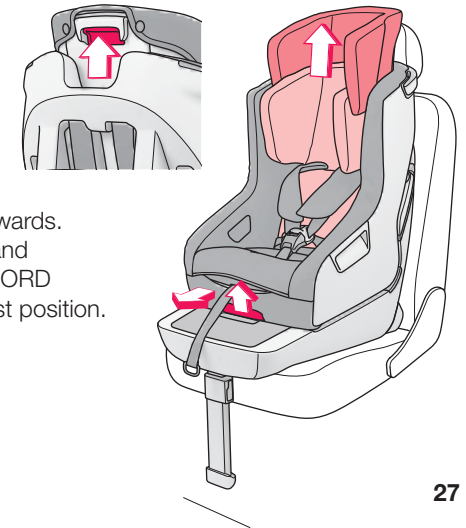

Push the seat tilt control (07) upwards. Press and hold the control (07) and move the seat part of the CONCORD ABSORBER into its forward-most position.

Open the harness lock of the 5-point harness system and fold the cover of the belt tensioner (06) upwards.

Push the locker button on the belt tensioner upwards and open the belt tensioner (06) completely.

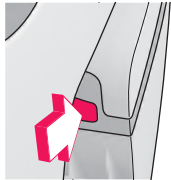
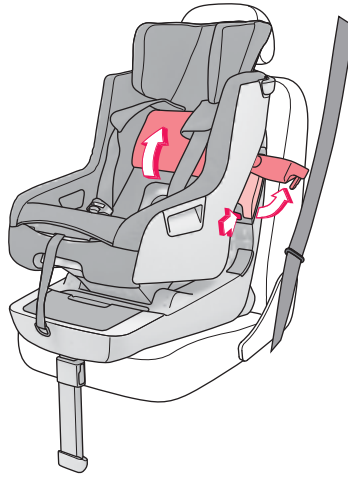
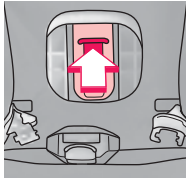
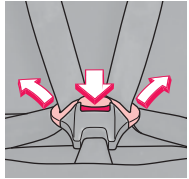

Open the harness clip for the shoulder belt (14) on the side of the lap and diagonal belt by pressing the control button on the harness clip (04).

Run the lap and diagonal seat belt between the seat part and the base of the CONCORD ABSORBER and close the lock of the three-point-harness.

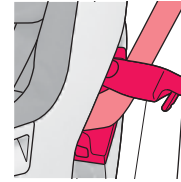
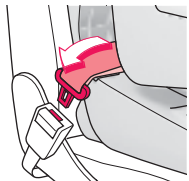

The shoulder belt must run inside the harness clip (14) and above the latch pin of the belt tensioner (06).

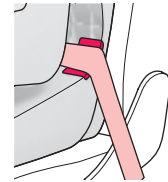
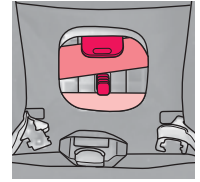

The lap strap must run on the lap strap guides marked in red and below the latch pin of the belt tensioner (06).

The seat belt must not be laid out in any other way. The seat belts must not be twisted!

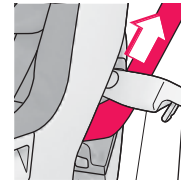

Pull the lap and diagonal belt until it lies flat and close the harness clip (14) carefully.

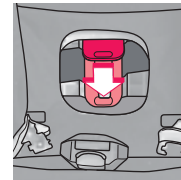
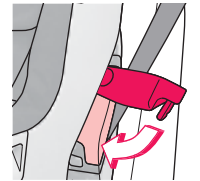

Now close the belt tensioner and tighten the seat belt as much as possible.

Close the cover of the belt tensioner. Hook the seat belt into the shoulder harness guide (13).

Press the button (10) to unlock the support leg, and move the support leg (11) downwards, until it rests securely on the floor and you can hear and feel it lock into position!

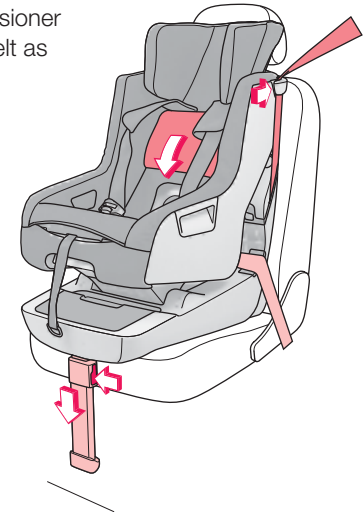

CAUTION!

- The lap and diagonal seat belt must be lying flat and fully tensioned along the base of the CONCORD ABSORBER.
- The seat belts must not be twisted.
- The shoulder strap must be run through the shoulder harness guide, the harness clip and the belt tensioner and must be fully tightened.
- The harness clip must be engaged and closed tightly.
- The support leg must rest securely on the floor and must be locked in place.

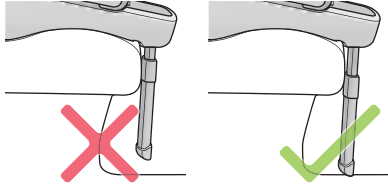

Check the correct position of the seat belts before each use.
Please contact CONCORD directly if you have problems mounting the seat.
The seat belts must run through the belt guides marked in red on the seat.
The seat belt must not be laid out in any other way.

REMOVING THE CONCORD ABSORBER WITH THE THREE-POINT SAFETY BELT

Press the size adjustment control (12) upwards and move the headrest of the CONCORD ABSORBER into its top-most position.
Press and hold the seat tilt control (07) upwards and move the seat part into its front-most position.

Remove the shoulder strap from the shoulder harness guide (13).

Push the support leg (11) into its top-most position while keeping the button for unlocking the support leg (10) pressed.

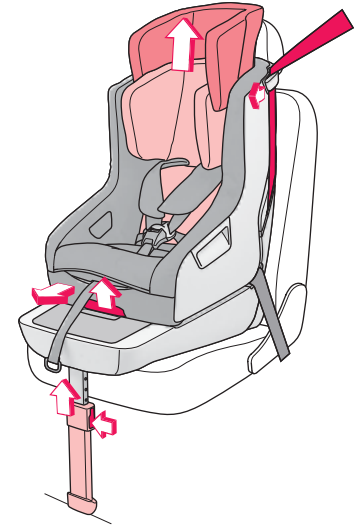

Open the harness lock of the 5-point harness system and fold the cover of the belt tensioner (06) upward. Push the locker button on the belt tensioner upwards and open the belt tensioner (06) completely.

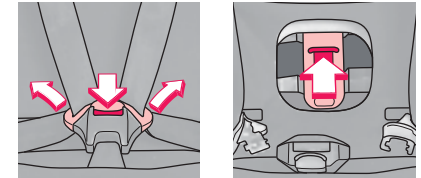

Open the harness clip for the shoulder belt (14) on the side by pressing the control button on the harness clip (04).

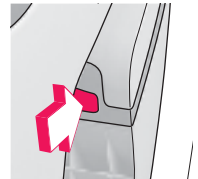

Open the belt lock of the lap and diagonal seat belt, and pull it out between the seat part and the base of the CONCORD ABSORBER.

_ MOUNTING THE CONCORD ABSORBER WITH ISOFIX

When the ISOFIX adapters has not been used for some time, they will be locked in their current position.

To unlock the adapters, lay the CONCORD ABSORBER on its back on an even, clean surface and push downwards on the seat area.

Fold the support leg (11) at the bottom of the CONCORD ABSORBER forwards until it engages.

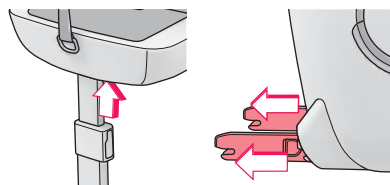
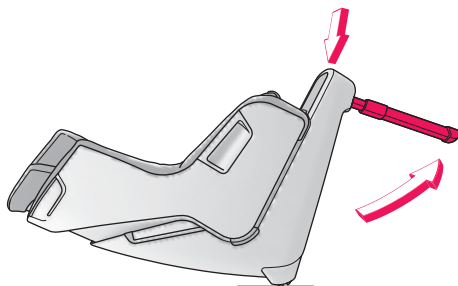

Press the ISOFIX control button (17) at the underside of the front edge upwards until the ISOFIX adapters (18) at the back of the seat are fully extended.

Set down the CONCORD ABSORBER in drive direction onto the seat or the seat bench.

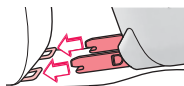

Push the child seat backwards onto the ISOFIX receptacles until the locking mechanisms of both ISOFIX adapters (18) audibly lock and the safety displays on both adapters are green!

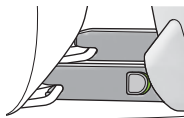

Push the CONCORD ABSORBER backwards while pushing down the ISOFIX control button (17) until it lies as flush as possible along the back rest of the vehicle's seat. Release the ISOFIX control button (17) once you have the child seat in the desired position.

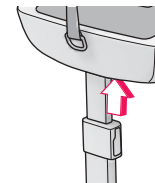

In vehicles with serial headrests, a readjustment of the headrest or its removal will allow for a better mounting position of the car seat.

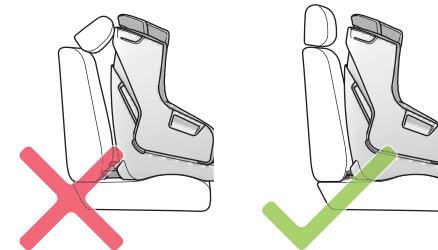

Please remember to readjust or replace the headrest in the correct position if an adult will be sitting in that seat instead.

Press the button (10) to unlock the support leg, and move the support leg (11) downwards, until it rests securely on the floor and you can hear and feel it lock into position!

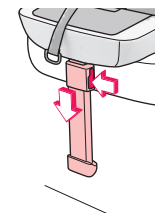

CAUTION!

- The car seat must be secured with the ISOFIX system, even if no child is traveling in it!
- Both ISOFIX adapters must be locked securely in place and the safety displays on both adapters must show green.
- The support leg must rest securely on the floor and must be locked in place.

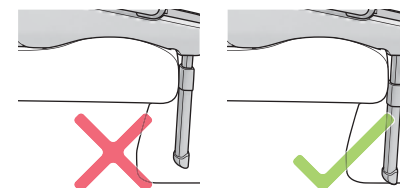

_ REMOVING THE CONCORD ABSORBER WITH ISOFIX

Move the support leg (11) upwards while keeping the button for unlocking the support leg (10) pressed.

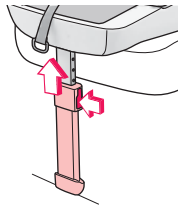

Press and hold the ISOFIX control button (17) and pull the CONCORD ABSORBER forward until the ISOFIX adapters are fully extended.

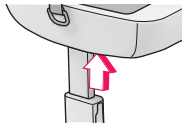

Push the buttons to unlock the ISOFIX adapters (18) forward until the safety displays are red and the seat is released.

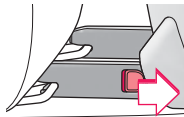

To retract the ISOFIX adapters (18), lay the CONCORD ABSORBER on its back on an even, clean surface and push downwards on the seat area while pressing and holding the ISOFIX control button (17).

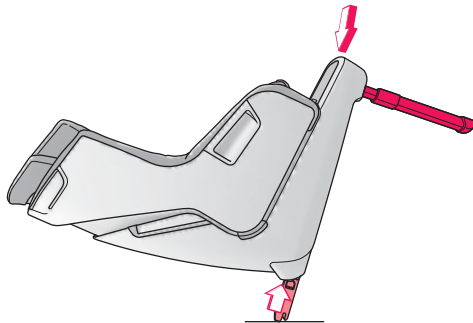

_ VEHICLES SUITABLE FOR ISOFIX

The CONCORD ABSORBER with ISOFIX system has been approved for ,semi universal' use, and is suitable for mounting on specific vehicle seats.

The appendix CAR FITTING LIST contains an overview of vehicles and vehicle seats that have been approved for the use of the CONCORD ABSORBER with lap and diagonal seat belt or ISOFIX system in connection with a support leg.

Should your vehicle not be listed, please ensure that the CONCORD ABSORBER can be properly mounted in your car/ on the desired seat before you purchase the child seat!

Read the user manual provided by the manufacturer of your vehicle and the mounting and security notices contained in this user manual.

For latest updates, please visit www.concord.de.

_ SECURING YOUR CHILD IN THE CONCORD ABSORBER

CAUTION

Check the CONCORD ABSORBER for proper mounting and correct seat belt tension, and for secure locking of all locking mechanisms before each use.

Press the size adjustment control (12) located on the back of the headrest upwards, and move the headrest of the CONCORD ABSORBER into its top-most position.

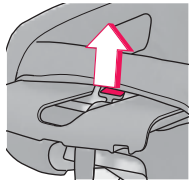
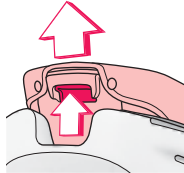

Push the arrester of the central adjuster upwards, while at the same time pulling the 5-point harness system forward by the lap harnesses.

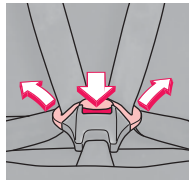

Open the harness lock and place the harnesses to the sides and forward.



Place your child onto the seat as far back as possible. Bring together the shoulder/ lap harnesses and the central harness in front of the child and push the harness lock closed.

Check that the harness lock has latched shut correctly. Ensure that none of the harness straps are twisted.

The CONCORD ABSORBER must be adjusted to the size of the child.

Press and hold the size adjustment control (12) located on the back of the headrest, and move the headrest of the CONCORD ABSORBER into the desired position.

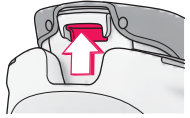

Releasing the control button (12) will lock the headrest (01) in its current position. The shoulder harness guide should be situated slightly above the child's shoulder. The shoulder harnesses should lie in the middle between the child's neck and the outer edge of the shoulder.

Tighten the harness by pulling the strap of the central adjuster (09) until it lies snug against the child's body.

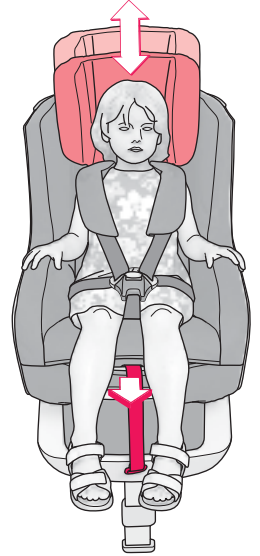
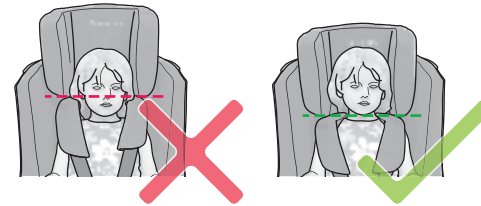

CAUTION!

- The seat belts must not be twisted.
- The harness lock must be locked properly and the harnesses must lie snug against the child's body.
- The headrest/ harness guide must be adjusted to the size of the child and latched securely in place.

_ USING THE TILT ADJUSTMENT

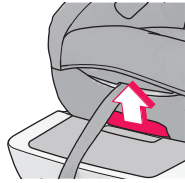
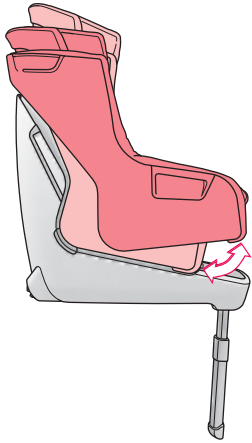

Press the seat tilt control (07) at the front of the seat part to tilt the CONCORD ABSORBER.

Hold the button down and move the seat into the desired position.

The CONCORD ABSORBER is locked in the current tilted position when you release the seat tilt control (07).

_ USING THE SUPPORT OF THE STEP-UP HELP

You can remove the support of the step-up help (08). To do so, tilt the CONCORD ABSORBER into its front-most position (see 'Using the tilt adjustment'). Move the support backwards and then lift it upwards and off its hooks.

To replace the support (08), hook it into the base of the CONCORD ABSORBER and then push the support (08) down and forwards.



_ USING THE LEG SUPPORT

The CONCORD ABSORBER is equipped with a removable leg support (05). The leg support is located at the front edge of the seat, and can easily be removed by grabbing the openings on the left and right.

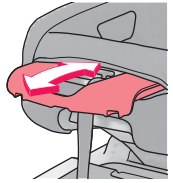

_ CARE TIPS

The cover can be removed for washing. Bring the seat part forward into its front-most position and the headrest (01) into its top-most position.

Simply pull the cover straight out of its fixture! Begin with removing the cover over the headrest (01), then take off the cover over the seat part.

When reattaching the cover, begin with the seat area. Stretch the cover underneath the headrest and push the attachments into the surrounding groove.

Now attach the cover over the headrest (01). Pull the cover upwards and over the cover plate and then over the headrest.

Attach the cover by way of the snap fasteners on the CONCORD ABSORBER.

- The cover material colour may run slightly when wet, in particular during washing.
- Do not use solvents on the cover!



_ WARRANTY

The guarantee begins on the day of purchase. The guarantee period corresponds to the statutory warranty period in the end-user's country concerned. At the manufacturer's discretion, the guarantee shall cover rectification, replacement or a price reduction.

The guarantee is valid for the original purchaser only. In the event of any defect, claims can not be considered unless the specialist dealer is notified of the fault as soon as it occurs for the first time. If the specialist dealer is unable to remedy the problem himself, he must return the product to the manufacturers together with details of the complaint, official proof of purchase and the purchase date. The manufacturers assume no liability for faulty goods that they did not supply.

The guarantee does not apply where:

- the product has been modified;
- the product is not brought back to the specialist dealer complete with proof of purchase within 14 days of the defect occurring;
- the defect was caused by improper usage or maintenance or due to anything else deemed to be the fault of the user, in particular failure to comply with the instructions for use;
- repairs have been carried out on the product by third parties;
- the defect was caused as the result of an accident.
- the serial number has been damaged or removed

The guarantee makes no provision for any alteration or deterioration to the product that is incurred through normal usage (wear and tear). The period of guarantee shall not be extended by any remedial measures carried out by the manufacturers in the event of a claim.

CONCORD ABSORBER XT

D // Um die Funktionsfähigkeit und Sicherheit Ihres Kinderautositzes auch nach dem Austausch von Ersatz- und Zubehörteilen zu gewährleisten, bitten wir Sie bei Bestellungen Ihrem Fachhändler nachstehende Angaben mitzuteilen:

GB // To ensure the functionality and safety of your child's car seat after replacing spare and accessory parts, please provide your dealer with the following details when placing your order:

F // Dans le but d'assurer le bon fonctionnement et la sécurité de votre siège auto enfant, également en cas de remplacement de pièces de rechange et accessoires, nous vous prions de bien vouloir, en cas de commande, donner les renseignements suivants à votre revendeur :

E // Para seguir garantizando el correcto funcionamiento y la seguridad de su asiento para niños después del cambio de piezas o accesorios, le rogamos que indique los siguientes datos al realizar pedidos a su comercio especializado.

I // Quando trasmette un ordine al Suo rivenditore di fiducia, La preghiamo di comunicargli i dati seguenti per garantire la funzionalità e la sicurezza del Suo seggiolino per bambini anche dopo la sostituzione di parti di ricambio e di accessori.

P // Para garantir a funcionalidade e a segurança da cadeira de criança para automóvel depois da substituição de peças sobressalentes e de acessórios, agradecemos o fornecimento dos dados seguintes à loja especializada aquando de encomendas:

NL // Om de functionaliteit en de veiligheid van het door u gekochte autokinderzitje ook na vervanging van onderdelen en accessoires te waarborgen, is het belangrijk dat u bij de bestelling in uw specialzaak onderstaande gegevens vermeldt:

N // Bilbarnesetet som du kjøpte, skal fungere riktig og gi optimal sikring også etter at reservedeler eller tilbehør er byttet ut. Ved eventuelle bestillinger ber vi deg derfor om å gi forhandleren følgende opplysninger:

DK // For at garantere at autostolen stadig er funktionsdygtig og sikker, også efter at der er blevet monteret reservedele eller tilbehør, bedes De oplyse følgende til Deres forhandler ved bestillingen:

FIN // Lasten turvaistuiemen toiminnan ja turvallisen käytön varmistamiseksi myös varaosien tai lisävarusteiden asennuksen jälkeen anna jälleenmyyjälle seuraavat tiedot, kun tilaat osia:

_____ ①
ECE-Nr. / ECE No. / N° ECE / Número ECE / N° ECE
N°. ECE / ECE-nr. / ECE-nr / ECE-nr. / ECE-nro

_____ ②
Serien-Nr. / Serial No. / N° de série / Número de serie / N° di serie
N° de série / Serie-nr. / Serienr. / Serienr. / Sarjanro

_____ ③
Ersatzteil / Spare part / Type de siège / Pieza de repuesto / Parte di ricambio
Peça / Type kinderzitje / Reservedel / Reservedel / Varaosa

_____ ④
Fachhändler / Dealer / Revendeur / Comercio especializado / Rivenditore specializzato
Loja especializada / Specialzaak / Forhandler / Forhandler / Jälleenmyyjä

_____ ⑤
Meine Anschrift / My address / Mon adresse / Mi dirección / Il mio indirizzo
Meu endereço / Mijn adres / Min adresse / Min adresse / Oma osoite

CONCORD

Industriestraße 25
95346 Stadtsteinach
Made in Germany

semi-universal
9-18 kg

E1

① 04.....

② 000000000

_ **DEUTSCH**
_ **ENGLISH**
_ **FRANÇAIS**
_ **ESPAÑOL**
_ **ITALIANO**
_ **PORTUGUÊS**
_ **NEDERLANDS**
_ **NORSK**
_ **DANSK**
_ **SUOMI**

Einbau- und Bedienungsanleitung
Instructions for attachment and use
Directives d'installation et mode d'emploi
Instrucciones de montaje y de uso
Istruzioni per l'uso e il montaggio
Manual de montagem e de utilização
Inbouw- en bedieningshandleiding
Bruksanvisning og monteringsveiledning
Monterings- og betjeningsvejledning
Kiinnitys- ja käyttöohjeet

Concord GmbH
Industriestraße 25
95346 Stadtsteinach
Germany

Phone +49 (0)9225.9550-0
Fax +49 (0)9225.9550-55
info@concord.de

www.concord.de



ABTF 02/0710